

QS SERIES

Walk-In Coolers & Freezers With Self-Contained Refrigeration Systems



FEATURES

- Cooler or freezer models
- Sizes from 4' x 6' to 10' x 14'
- Three heights: 6'7" & 7'7" with floor; 7'4" floorless
- Indoor or outdoor models
- Two temperatures: +37°F, -10°F
- Ceiling mount Capsule Pak refrigeration system (ordered separately)
- Air-cooled condensing unit
- LogiTemp® electronic controller system
- 26 gauge corrosion resistant stucco embossed coated steel on all surfaces except interior floor
- Smooth aluminum interior floor (on models with floor)
- Floorless models supplied with NSF listed vinyl sealers
- Full 4" thick panels foamed-in-place with EPA-compliant polyurethane insulation
- 26" wide, self-closing door
- Heavy duty adjustable cam-lift hinges
- Spring actuated door closer
- Deadbolt locking handle with independent key/padlock feature and inside safety release
- Magnetic gasket
- Digital thermometer and light switch
- Floor double sweep gasket
- Perimeter door heater wire
- High output low profile LED light positioned above the door to prevent interference with shelving or product
- UL and C-UL listing on complete Capsule Pak and Capsule Pak ECO refrigeration systems*
- UL NCKL listed certifying compliant walk-ins are ignition protected
- NSF listed, UL flame spread 25 or less on all foam cores; UL electrical listing on door sections
- City of Houston listed
- California State listed
- CN UL flame spread listed
- DOE compliant
- Oregon State listed
- USDA accepted
- 15 year panel warranty
- 18 months parts & labor warranty
- Indoor models feature hot gas or wick condensate vaporizer
- Outdoor models:
 - White membrane roof and trim
 - -20°F ambient controls
 - Outdoor cooler models with Capsule Pak ECO refrigeration systems feature a heater to prevent product loss in low ambient conditions

Equipped with YOUR CHOICE of SELF-CONTAINED Capsule Pak™ refrigeration systems



CAPSULE PAK
 With R449A
 Refrigerant



CAPSULE PAK ECO™
 With R290
 Refrigerant

OPTIONS

(Most options available two weeks from receipt of order. Please contact us for specific questions.)

- Heights: 8'7" with floor, 8'4" without floor
- U-shaped shelving system
- Floor tread plate kit
- Exterior ramp
- Door hood (outdoor models)
- Heater kit for outdoor use with medium temp applications where ambient conditions may go below 32°F (standard on models with Capsule Pak ECO refrigeration systems)
- Leak detector/alarm (may be a requirement in some areas)
- Electric vaporizer (indoor models only)
- Five year compressor warranty

* C-UL is Underwriters Laboratories Safety Certification Mark which indicates that UL has tested the equipment to applicable CSA Standards.

WALK-IN SPECIFICATIONS

QS Series walk-ins are built of modular panels and are insulated with foamed-in-place EPA-compliant polyurethane insulation. Each panel is designed to ensure ease of installation, long term reliability and high insulating efficiency.

A. All panels are manufactured with male and female mating rails to ensure proper alignment during installation. The polyurethane insulation wraps around the return bend metal seams on both section to create a lightweight panel of exceptional strength and durability. All panels are a full four (4) inches thick and provide a superior insulating value.

B. The foamed-in-place cam locking fasteners ensure an airtight seal for maximum energy efficiency.

C. Panel gaskets located around the outer perimeter of the panel are continuous, without cuts or breaks at corners. Because gaskets are foamed-in-place as an integral part of the panel, they cannot fall off or pull off during shipment or installation.

D. Panels lock together tightly for an energy efficient walk-in.

E. Edge caps for ends of floor and ceiling panels are foamed-in-place rather than overlapped or mechanically fastened. Edge caps cannot come loose, and they stay in place through the life of the walk-in.

F. Panel Finishes: Interior and exterior panels are fabricated with 26 gauge corrosion resistant stucco embossed coated steel. Models supplied with a floor will include a smooth aluminum interior floor surface.

G. Insulation: Panels are four (4) inches thick, metal clad and foamed-in-place with HFO polyurethane insulation which is HFC free.

The minimum R-values for 4" HFO panels are:

Cooler:

Walls/Ceilings R-value 25

Doors R-value 25

Freezer:

Walls/Ceilings R-value 32

Doors R-value 32

Floors R-value 28

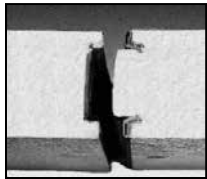

A.

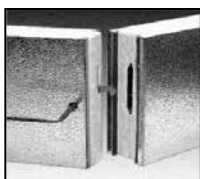

B.

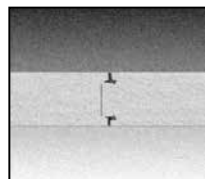

C.

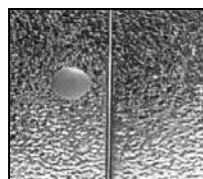

D.

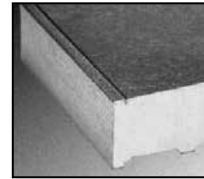

E.

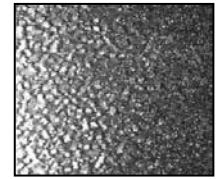

F.

AVAILABLE SIZES

The Standard Series of QS Series walk-ins are all 6'-7" high and are all supplied with a floor. The sizes available are as follows: 4' wide x 6' long, 6' wide x 6' long, 6' wide x 8' long, 6' wide x 10' long, 6' wide x 12' long, 8' wide x 8' long, and 8' wide x 10' long.

The 77 Series of QS Series walk-ins are all 7'-7" high and are all supplied with a floor. The sizes available are as follows: 6' wide x 6' long, 6' wide x 8' long, 6' wide x 10' long, 6' wide x 12' long, 8' wide x 8' long, and 8' wide x 10' long.

The 74 Series of QS Series walk-ins are all 7'-3⁵/₈" high and are all supplied without a floor. Wall panels are installed on top of NSF listed vinyl sealers provided. The sizes available are as follows: 6' wide x 6' long, 6' wide x 8' long, 6' wide x 10' long, 6' wide x 12' long, 8' wide x 8' long, and 8' wide x 10' long.

OUTDOOR MODELS

All QS Series walk-ins installed outdoors include a weather protection kit consisting of: One piece, 35 mill, white membrane roof material which requires no seaming or gluing to the top of the QS Series walk-in ceiling panels.

Metal trim for flashing the membrane roof material to the side of the QS Series walk-in wall panels is included.

Trim is secured to the QS Series wall panels with self-drilling and self-tapping TEK screws. In applications where the QS Series walk-in is installed next to a building, the trim can be used to secure the turned up membrane roof material to the building wall, with fasteners supplied. Door rain hoods are an option and should be included on installations where the door panels are exposed to the outdoor weather.

DOOR

Door sections are factory tested to assure proper fit, performance and alignment. All doors feature a stepped profile design that serves as a barrier to air flow which results in an energy efficient door system. Door sections are 4" thick, metal clad and foamed-in-place with EPA-compliant polyurethane insulation.

Each QS Series walk-in compartment is equipped with a 26" wide door opening. The height of the door opening varies with the series of walk-in ordered. The Standard Series (6'7" high) has a 66" high door opening and the 74 and 77 Series walk-ins have a 78" high door opening. The door is self-closing, flush mounted, infitting and constructed to incorporate heavy duty, molded ABS breaker which is permanently foamed-in-place.

Doors are available with right or left side hinges and include two field adjustable cam-lift hinges with locking set screw, top hinge spring loaded, spring actuated door closer, NL 9800 deadbolt locking handle with independent key/padlock feature and inside safety release. The doors are pre-hung in a four foot wide frame panel which is equipped with replaceable perimeter heater wire, magnetic stainless steel trim, digital thermometer, vapor proof LED light fixture and switch with exterior pilot indicator light.

The door section is completely pre-wired within concealed conduit inside the door frame panel. 120/60/1 electrical is field wired to a junction box which is surface mounted next to the interior frame above the vapor proof LED light fixture.

Hinges and door handle are mounted to heavy-duty tapping plates. Each door section is complete with a fiberglass reinforced plastic heated threshold.

DOOR OPENING SIZE		
W	H	MODEL
26"	66"	STD Series
26"	78"	74 Series
26"	78"	77 Series

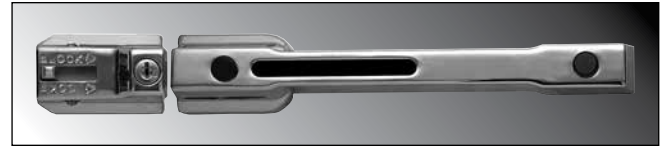

Deadbolt-locking handle



Spring actuated door closer

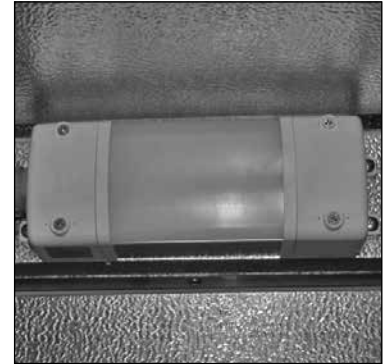

LED light fixture

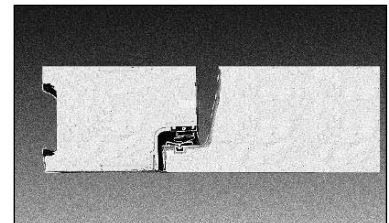

Doors feature a stepped profile design



Digital thermometer/light switch

These doors are designed and certified for use in walk-in cooler applications.

DOOR MODEL NUMBER	ENERGY CONSUMPTION (KWH/DAY)	DOOR SURFACE AREA (SQ. FT.)	ELECTRICAL	WATTS	AMPS
QS26X66	2.37	13.40	120/60/1	100.80	0.84
QS26X78	2.49	15.80	120/60/1	106.07	0.88

These doors are designed and certified for use in walk-in freezer applications.

DOOR MODEL NUMBER	ENERGY CONSUMPTION (KWH/DAY)	DOOR SURFACE AREA (SQ. FT.)	ELECTRICAL	WATTS	AMPS
QS26X66	6.68	13.40	120/60/1	196.07	1.63
QS26X78	7.01	15.80	120/60/1	207.07	1.73

FLOOR CONSTRUCTION

Floor panels (when supplied) are similar in construction to the wall panels except they are made to withstand uniformly distributed floor loads of up to 800 pounds per square foot. The interior floor metal is smooth aluminum.

The 74 Series, floorless models, are supplied with a patented vinyl floor sealer to stop conductivity at floor level. This unique sealer sits flat on existing floors and fits tightly against the interior/ exterior wall panels. The walk-in wall panel is supported on the shoulder of the sealer so the foam edge is free of compressing weight. The vinyl floor sealer is NSF listed.



Floorless models are supplied with a patented vinyl floor sealer

SHELVING KITS

Shelving kits specifically designed for each QS Series walk-in configuration are offered as an optional extra. These kits are shipped with the QS Series walk-in and Capsule Pak refrigeration system so that all necessary components are at your location promptly when you need them. The shelving sets are coded to correspond to the QS Series walk-in configuration ordered and are offered in either three or four tier.



Shelving system types include Green Kote™ and Chrome Kote™

SHELVING SYSTEM TYPES

A. Green Kote™ Shelving: Electrostatically applied green baked epoxy over zinc steel and brite basic wire. Thickness: 2-3 mill. 15 year guarantee against corrosion.

B. Standard Chrome Kote™ Shelving: Plated quality wire and steel. Surface nickel chrome plated.

Select the shelving finish of your choice. Shelving posts are engineered for maximum strength. Shelves are adjustable on 2" centers. All shelves are NSF listed and are zinc coated with a heavy layer of Protoxy for a maximum life span under humid storage conditions. Special clips are utilized to gain the maximum square footage of storage space for each QS Series model. 14", 18" and 24" wide shelves are used as required for maximum storage capacity in each set. This wire shelving is ideal for storage of all refrigerated or frozen products.

SHELVES

Shelves to have #9 (.148") ga. crosswires spaced 3/4" on centers with crossbraces 1/4" (.192") minimum of 4-3/4" on center.

- **Shelf Frames:** Channel to be 9/16" x 1" x .075" thick.
- **Shelf Collars:** A round tapered 1-5/16" high steel collar to be welded at each corner.

POSTS

Posts to be .062" thick 1" O.D. round tubing notched every 2" on each corner of the post.

POST LEVELERS

Installed on the bottom of each post is nylon housing for a steel leveler 3/8"-16 x 1-3/4".

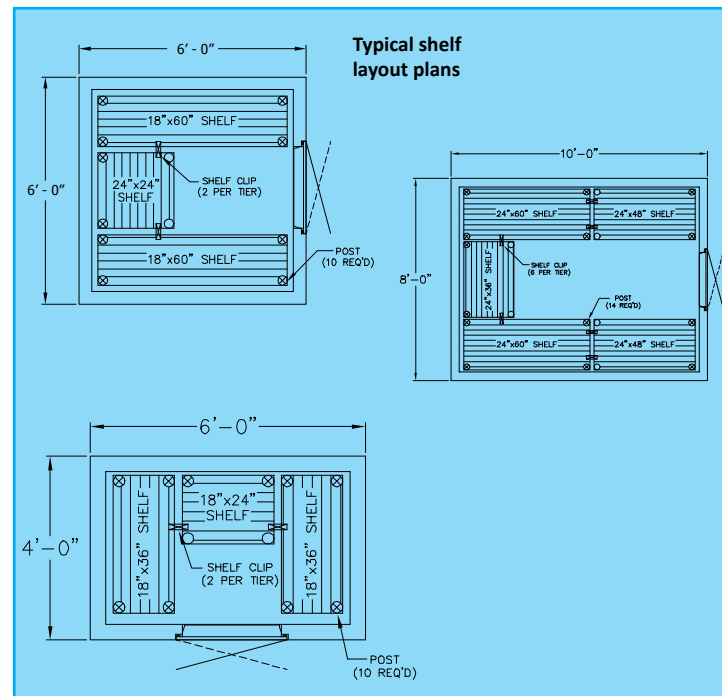

STANDARD SELF-CONTAINED REFRIGERATION SYSTEMS

CHOOSE FROM THESE SYSTEM OPTIONS

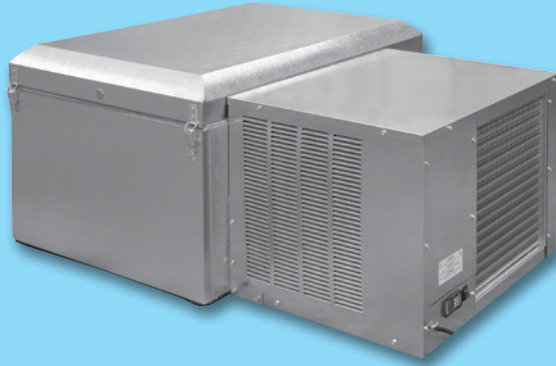

**CAPSULE PAK™
WITH R449A REFRIGERANT**

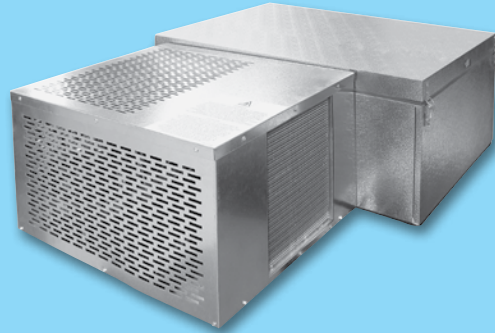

**CAPSULE PAK ECO™
WITH R290 NATURAL REFRIGERANT**

FEATURE	CAPSULE PAK	CAPSULE PAK ECO
Factory assembled, wired, charged, tested and ready to mount in walk-in ceiling	✓	✓
Indoor and outdoor models	✓	✓
Available for coolers (+37°F) or freezers (-10°F)	✓	✓
Flush mounted evaporator coil in the walk-in ceiling panel for maximum interior storage space	✓	✓
Standard cord and plug eliminating the need for field electrical connection	✓	✓
Pre-charged with refrigerant eliminating the need for field refrigeration connection	✓	✓
Designed to operate in ambient temperatures up to 100°F	✓	✓
Air cooled condensing unit	✓	✓
LogiTemp® electronic controller system provides increased reliability, connectivity and food safety	✓	✓
Automatic condensate evaporator (indoor models only)	✓	✓
Electronic control provided for automatic defrost on both coolers and freezers	✓	✓
UL and C-UL electrical listing on complete Capsule Pak refrigeration systems*	✓	✓
AWEF compliant	✓	✓
DOE, CARB and SNAP compliant	✓	✓
-20°F ambient controls (outdoor models)	✓	✓
Systems for outdoor walk-ins contain a crankcase heater	✓	✓
Systems for outdoor walk-ins contain a head master	✓	⊗
Patented technology	⊗	✓
Heater in outdoor cooler models prevents product from freezing in low ambient conditions (patent pending)	⊗	✓
18 months parts and labor warranty	✓	✓
Optional electric vaporizer (indoor models only)	✓	✓
Optional condensing unit air deflection kit	✓	✓
Optional 5 year compressor warranty	✓	✓

* C-UL is Underwriters Laboratories Safety Certification Mark which indicates that UL has tested the equipment to applicable CSA Standards.

CAPSULE PAK™ & CAPSULE PAK ECO™ REFRIGERATION SYSTEM SPECIFICATIONS

Capsule Pak™ and Capsule Pak ECO™ refrigeration systems consist of a single assembly pre-charged condensing unit and evaporator coil factory assembled, wired, tested and ready for insertion into a factory prepared walk-in ceiling opening.

Capsule Pak and Capsule Pak ECO systems are ceiling mount. A flush evaporator coil keeps all components outside the walk-in storage area allowing more storage inside. Capsule Pak and Capsule Pak ECO models are available for indoor or outdoor installations. Models are available for interior compartment design temperatures of +37°F and -10°F. Installation is fast and easy with no plumbing required on indoor units.

The evaporator section is designed to be located entirely outside the walk-in with no intrusions into the refrigerated space. The evaporator enclosure is constructed utilizing foamed-in-place polyurethane insulation and equipped with a removable, gasketed access cover. High efficiency EC evaporator fan motors circulate air throughout the walk-in.

Indoor Capsule Pak models are equipped with either a discharge gas condensate vaporizer or an optional electric condensate vaporizer. Outdoor Capsule Pak models are equipped with low ambient controls consisting of crankcase heater and flooded condenser head pressure control. Capsule Pak ECO models incorporate a condensate pan with wicking pads and forced air from the condenser fan to evaporate condensate. Capsule Pak ECO models also include crankcase heaters for low ambient conditions.

Capsule Pak and Capsule Pak ECO systems are UL and C-UL listed and DOE compliant. Note: Allow minimum of 4" clearance above and 24" on each side of the system for installation. Consideration should be given to accessibility for service and free condenser air flow. Consult factory with installation questions.

**STANDARD LOGITEMP® ELECTRONIC CONTROLLER ON ALL CAPSULE PAK & CAPSULE PAK ECO SYSTEMS**

- More precise and reliable temperature control compared to all-mechanical systems
- Digital readout and four button overlay for easy setup and navigation
- Demand Defrost technology that initiates defrosts only as needed for further energy savings (optional on Capsule Pak ECO cooler models)
- LogiTemp provides online data for instant notification of error codes and settings (optional on Capsule Pak ECO cooler models)

FLOOR PLAN LAYOUTS FOR SINGLE ROOM COOLERS OR FREEZERS

Model numbers indicate the door location on the standard QS Series layouts

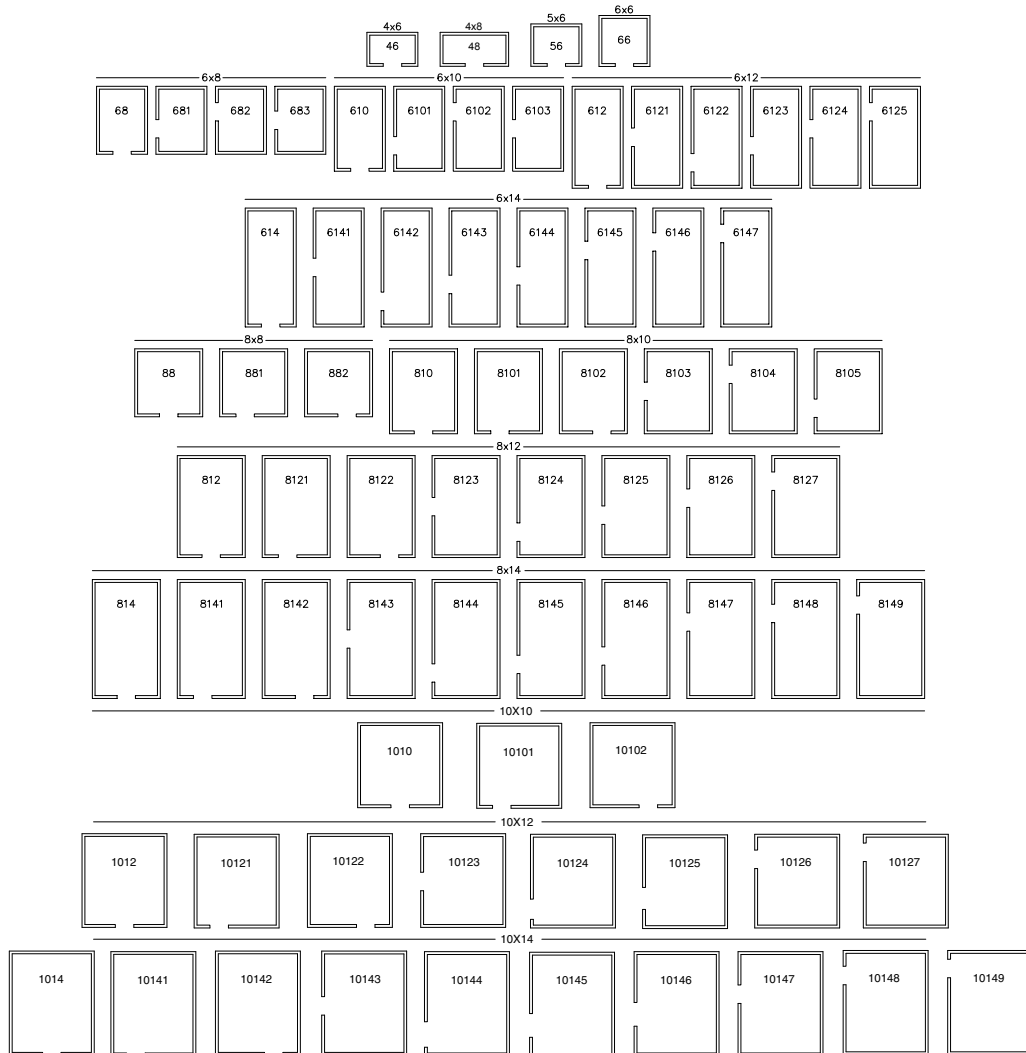

PHYSICAL SPECIFICATIONS

6'7" HIGH		7'4" HIGH & 7'7" HIGH	
MODEL	CAPACITY CU. FT.	MODEL	CAPACITY CU. FT.
QS46 (4' x 6')	105	QS7746	123
QS56 (5' x 6')	137	QS7756	159
QS66 (6' x 6')	168	QS7766	196
QS68 (6' x 8')	231	QS7768	270
QS610 (6' x 10')	295	QS77610	344
QS612 (6' x 12')	357	QS77612	418
QS614 (6' x 14')	420	QS77614	490
QS88 (8' x 8')	318	QS7788	372
QS810 (8' x 10')	404	QS77810	473
QS812 (8' x 12')	490	QS77812	574
QS814 (8' x 14')	578	QS77814	675
QS1010 (10' x 10')	515	QS771010	602
QS1012 (10' x 12')	625	QS771012	731
QS1014 (10' x 14')	736	QS771014	860

MATCHING REFRIGERATION SYSTEMS

QS SERIES MODEL	SELF-CONTAINED ONE-PIECE CEILING MOUNT							
	-10°F, 90° AMBIENT				+37°F to +38°F, 90° AMBIENT			
	CAPSULE PAK™ MODEL	BTUH*	CAPSULE PAK ECO™ MODEL	BTUH*	CAPSULE PAK™ MODEL	BTUH*	CAPSULE PAK ECO™ MODEL	BTUH*
6'7" HIGH WITH FLOOR								
QS46	CPF060JC-S-4-EV	2250	CPF050PC-S-0	1600	CPB050JC-S-O-EV	4400	CPB050PC-S-0	4100
QS56	CPF075JC-S-4-EV	3130	CPF075PC-S-0	2900	CPB050JC-S-O-EV	4400	CPB050PC-S-0	4100
QS66	CPF075JC-S-4-EV	2637	CPF075PC-S-0	2900	CPB050JC-S-O-EV	4400	CPB050PC-S-0	4100
QS68	CPF100JC-S-4-EV	3500	CPF100PC-S-0	3600	CPB050JC-S-O-EV	4400	CPB050PC-S-0	4100
QS610	CPF100JC-S-4-EV	3444	CPF100PC-S-0	3600	CPB075JC-S-4-EV	6385	CPB075PC-S-0	6700
QS612	CPF150JC-S-4-EV	4509	CPF150PC-S-4	4400	CPB075JC-S-4-EV	6385	CPB075PC-S-0	6700
QS614	CPF200JC-S-4-EV	6725	N/A	N/A	CPB075JC-S-4-EV	6385	CPB075PC-S-0	6700
QS88	CPF150JC-S-4-EV	4509	CPF150PC-S-4	4400	CPB075JC-S-4-EV	6385	CPB075PC-S-0	6700
QS810	CPF150JC-S-4-EV	4509	CPF150PC-S-4	4400	CPB075JC-S-4-EV	6385	CPB075PC-S-0	6700
QS812	CPF150JC-S-4-EV	4509	CPF150PC-S-4	4400	CPB075JC-S-4-EV	6385	CPB075PC-S-0	6700
QS814	CPF200JC-S-4-EV	6725	N/A	N/A	CPB075JC-S-4-EV	6385	CPB075PC-S-0	6700
QS1010	CPF200JC-S-4-EV	6725	N/A	N/A	CPB075JC-S-4-EV	6385	CPB075PC-S-0	6700
QS1012	CPF200JC-S-4-EV	6725	N/A	N/A	CPB075JC-S-4-EV	6385	CPB075PC-S-0	6700
QS1014	CPF200JC-S-4-EV	6725	N/A	N/A	CPB100JC-S-4-EV	7300	CPB100PC-S-0	8800
6'7" HIGH WITH FLOOR OUTDOOR								
QOD46	CPF060JC-E-4-EV	2135	CPF075PC-E-0	2800	CPB050JC-E-O-EV	4115	CPB050PC-E-0	4100
QOD56	CPF075JC-E-4-EV	2875	CPF075PC-E-0	2800	CPB050JC-E-O-EV	4115	CPB050PC-E-0	4100
QOD66	CPF075JC-E-4-EV	2875	CPF075PC-E-0	2800	CPB050JC-E-O-EV	4115	CPB050PC-E-0	4100
QOD68	CPF100JC-E-4-EV	3210	CPF100PC-E-0	3600	CPB050JC-E-O-EV	4115	CPB050PC-E-0	4100
QOD610	CPF100JC-E-4-EV	3210	CPF100PC-E-0	3600	CPB075JC-E-4-EV	5802	CPB075PC-E-0	6700
QOD612	CPF150JC-E-4-EV	4362	CPF150PC-E-4	4300	CPB075JC-E-4-EV	5802	CPB075PC-E-0	6700
QOD614	CPF200JC-E-4-EV	6350	N/A	N/A	CPB100JC-E-4-EV	6884	CPB100PC-E-0	8800
QOD88	CPF100JC-E-4-EV	3210	CPF100PC-E-0	3600	CPB075JC-E-4-EV	5802	CPB075PC-E-0	6700
QOD810	CPF100JC-E-4-EV	3210	CPF100PC-E-0	3600	CPB075JC-E-4-EV	5802	CPB075PC-E-0	6700
QOD812	CPF100JC-E-4-EV	3210	CPF100PC-E-0	3600	CPB100JC-E-4-EV	6884	CPB100PC-E-0	8800
QOD814	CPF200JC-E-4-EV	6350	N/A	N/A	CPB100JC-E-4-EV	6884	CPB100PC-E-0	8800
QOD1010	CPF200JC-E-4-EV	6350	N/A	N/A	CPB100JC-E-4-EV	6884	CPB100PC-E-0	8800
QOD1012	CPF200JC-E-4-EV	6350	N/A	N/A	CPB100JC-E-4-EV	6884	CPB100PC-E-0	8800
QOD1014	CPF200JC-E-4-EV	6350	N/A	N/A	CPB100JC-E-4-EV	6884	CPB100PC-E-0	8800
7' 4" HIGH LESS FLOOR - INDOOR ONLY								
QS7446	N/A	N/A	N/A	N/A	CPB050JC-S-O-EV	4400	CPB050PC-S-0	4100
QS7456	N/A	N/A	N/A	N/A	CPB050JC-S-O-EV	4400	CPB050PC-S-0	4100
QS7466	N/A	N/A	N/A	N/A	CPB050JC-S-O-EV	4400	CPB050PC-S-0	4100
QS7468	N/A	N/A	N/A	N/A	CPB050JC-S-O-EV	6250	CPB050PC-S-0	4100
QS74610	N/A	N/A	N/A	N/A	CPB075JC-S-4-EV	6250	CPB075PC-S-0	6700
QS74612	N/A	N/A	N/A	N/A	CPB075JC-S-4-EV	6250	CPB075PC-S-0	6700
QS74614	N/A	N/A	N/A	N/A	CPB075JC-S-4-EV	6250	CPB075PC-S-0	6700
QS7488	N/A	N/A	N/A	N/A	CPB075JC-S-4-EV	6250	CPB075PC-S-0	6700
QS74810	N/A	N/A	N/A	N/A	CPB075JC-S-4-EV	6250	CPB075PC-S-0	6700
QS74812	N/A	N/A	N/A	N/A	CPB075JC-S-4-EV	6250	CPB075PC-S-0	6700
QS74814	N/A	N/A	N/A	N/A	CPB100JC-S-4-EV	6250	CPB075PC-S-0	6700
QS741010	N/A	N/A	N/A	N/A	CPB075JC-S-4-EV	6250	CPB075PC-S-0	6700
QS741012	N/A	N/A	N/A	N/A	CPB100JC-S-4-EV	8484	CPB100PC-S-0	8800
QS741014	N/A	N/A	N/A	N/A	CPB100JC-S-4-EV	8484	CPB100PC-S-0	8800

*BTUH calculated using 16 hour design runtimes on coolers and 20 hour design runtimes on freezers.

MATCHING REFRIGERATION SYSTEMS

QS SERIES MODEL	SELF-CONTAINED ONE-PIECE CEILING MOUNT							
	-10°F, 90°F AMBIENT				+37°F to +38°F, 90°F AMBIENT			
	CAPSULE PAK™ MODEL	BTUH*	CAPSULE PAK ECO™ MODEL	BTUH*	CAPSULE PAK™ MODEL	BTUH*	CAPSULE PAK ECO™ MODEL	BTUH*
7' 7" HIGH WITH FLOOR								
QS7746	CPF050JC-S-4-EV	4400	CPF050PC-S-0	1600	CPB050JC-S-0-EV	4400	CPB050PC-S-0	4100
QS7748	CPF075JC-S-4-EV	3130	CPF075PC-S-0	2900	CPB050JC-S-0-EV	4400	CPB050PC-S-0	4100
QS7756	CPF075JC-S-4-EV	3130	CPF075PC-S-0	2900	CPB050JC-S-0-EV	4400	CPB050PC-S-0	4100
QS7766	CPF100JC-S-4-EV	3500	CPF075PC-S-0	2900	CPB050JC-S-0-EV	4400	CPB050PC-S-0	4100
QS7768	CPF100JC-S-4-EV	3500	CPF100PC-S-0	3600	CPB050JC-S-4-EV	4400	CPB050PC-S-0	4100
QS77610	CPF150JC-S-4-EV	4509	CPF150PC-S-4	4400	CPB075JC-S-4-EV	6366	CPB075PC-S-0	6700
QS77612	CPF150JC-S-4-EV	4509	CPF150PC-S-4	4400	CPB075JC-S-4-EV	6366	CPB075PC-S-0	6700
QS77614	CPF200JC-S-4-EV	6725	N/A	N/A	CPB075JC-S-4-EV	6366	CPB075PC-S-0	6700
QS7788	CPF150JC-S-4-EV	4509	CPF150PC-S-4	4400	CPB075JC-S-4-EV	6366	CPB075PC-S-0	6700
QS77810	CPF150JC-S-4-EV	4509	CPF150PC-S-4	4400	CPB075JC-S-4-EV	6366	CPB075PC-S-0	6700
QS77812	CPF200JC-S-4-EV	6725	N/A	N/A	CPB075JC-S-4-EV	6366	CPB075PC-S-0	6700
QS77814	CPF200JC-S-4-EV	6725	N/A	N/A	CPB100JC-S-4-EV	7300	CPB100PC-S-0	8800
QS771010	CPF200JC-S-4-EV	6725	N/A	N/A	CPB075JC-S-4-EV	6366	CPB100PC-S-0	8800
QS771012	CPF200JC-S-4-EV	6725	N/A	N/A	CPB100JC-S-4-EV	7300	CPB100PC-S-0	8800
QS771014	CPF200JC-S-4-EV	6725	N/A	N/A	CPB100JC-S-4-EV	7300	CPB100PC-S-0	8800
7' 7" HIGH WITH FLOOR OUTDOOR								
QOD7746	CPF075JC-E-4-EV	2875	CPF075PC-E-0	2800	CPB050JC-E-0-EV	4115	CPB050PC-E-0	4100
QOD7756	CPF075JC-E-4-EV	2875	CPF075PC-E-0	2800	CPB050JC-E-0-EV	4115	CPB050PC-E-0	4100
QOD7766	CPF075JC-E-4-EV	2875	CPF075PC-E-0	2800	CPB050JC-E-0-EV	4115	CPB050PC-E-0	4100
QOD7768	CPF100JC-E-4-EV	3210	CPF100PC-E-0	3600	CPB050JC-E-0-EV	4115	CPB050PC-E-0	4100
QOD77610	CPF100JC-E-4-EV	3210	CPF100PC-E-0	3600	CPB075JC-E-4-EV	5802	CPB075PC-E-0	6700
QOD77612	CPF150JC-E-4-EV	4362	CPF150PC-E-4	4300	CPB100JC-E-4-EV	6884	CPB100PC-E-0	8800
QOD77614	CPF200JC-E-4-EV	6350	N/A	N/A	CPB100JC-E-4-EV	6884	CPB100PC-E-0	8800
QOD7788	CPF200JC-E-4-EV	6350	N/A	N/A	CPB075JC-E-4-EV	5802	CPB075PC-E-0	6700
QOD77810	CPF200JC-E-4-EV	6350	N/A	N/A	CPB075JC-E-4-EV	5802	CPB075PC-E-0	6700
QOD77812	CPF200JC-E-4-EV	6350	N/A	N/A	CPB100JC-E-4-EV	6884	CPB100PC-E-0	8800
QOD77814	CPF200JC-E-4-EV	6350	N/A	N/A	CPB100JC-E-4-EV	6884	CPB100PC-E-0	8800
QOD771010	CPF200JC-E-4-EV	6350	N/A	N/A	CPB075JC-E-4-EV	5802	CPB100PC-E-0	8800
QOD771012	CPF200JC-E-4-EV	6350	N/A	N/A	CPB100JC-E-4-EV	6884	CPB100PC-E-0	8800
QOD771014	CPF200JC-E-4-EV	6350	N/A	N/A	CPB100JC-E-4-EV	6884	CPB100PC-E-0	8800
8'4" HIGH LESS FLOOR								
QS8466	N/A	N/A	N/A	N/A	CPB050JC-S-0-EV	4400	CPB050PC-S-0	4100
QS8468	N/A	N/A	N/A	N/A	CPB050JC-S-4-EV	4400	CPB050PC-S-0	4100
QS84610	N/A	N/A	N/A	N/A	CPB075JC-S-4-EV	4400	CPB075PC-S-0	4100
QS84612	N/A	N/A	N/A	N/A	CPB075JC-S-4-EV	6366	CPB075PC-S-0	6700
QS84614	N/A	N/A	N/A	N/A	CPB0075C-S-4-EV	6366	CPB075PC-S-0	6700
QS8488	N/A	N/A	N/A	N/A	CPB075JC-S-4-EV	6366	CPB075PC-S-0	6700
QS84810	N/A	N/A	N/A	N/A	CPB075JC-S-4-EV	6366	CPB075PC-S-0	6700
QS84812	N/A	N/A	N/A	N/A	CPB100JC-S-4-EV	7300	CPB100PC-S-0	8800
QS84814	N/A	N/A	N/A	N/A	CPB100JC-S-4-EV	7300	CPB100PC-S-0	8800
8'7" HIGH WITH FLOOR								
QS8766	CPF075JC-S-4-EV	2875	CPF075PC-S-0	2900	CPB050JC-S-0-EV	4400	CPB050PC-S-0	4100
QS8768	CPF100JC-S-4-EV	3500	CPF100PC-S-0	3600	CPB050JC-S-4-EV	4400	CPB050PC-S-0	4100
QS87610	CPF150JC-S-4-EV	4509	CPF150PC-S-4	4400	CPB075JC-S-4-EV	6366	CPB075PC-S-0	6700
QS87612	CPF150JC-S-4-EV	4509	CPF150PC-S-4	4400	CPB075JC-S-4-EV	6366	CPB075PC-S-0	6700
QS87614	CPF200JC-S-4-EV	6725	N/A	N/A	CPB075JC-S-4-EV	6366	CPB075PC-S-0	6700
QS8788	CPF150JC-S-4-EV	4509	CPF150PC-S-4	4400	CPB075JC-S-4-EV	6366	CPB075PC-S-0	6700
QS87810	CPF150JC-S-4-EV	4509	CPF150PC-S-4	4400	CPB075JC-S-4-EV	6366	CPB075PC-S-0	6700
QS87812	CPF200JC-S-4-EV	6725	N/A	N/A	CPB100JC-S-4-EV	7300	CPB100PC-S-0	8800
QS87814	CPF200JC-S-4-EV	6725	N/A	N/A	CPB100JC-S-4-EV	7300	CPB100PC-S-0	8800
8'7" HIGH WITH FLOOR OUTDOOR								
QOD8766	CPF100JC-E-4-EV	3210	CPF100PC-E-0	3600	CPB050JC-E-0-EV	4115	CPB050PC-E-0	4100
QOD8768	CPF100JC-E-4-EV	3210	CPF100PC-E-0	3600	CPB050JC-E-0-EV	4115	CPB050PC-E-0	4100
QOD87610	CPF150JC-E-4-EV	4362	CPF150PC-E-4	4300	CPB075JC-E-4-EV	5802	CPB075PC-E-0	6700
QOD87612	CPF150JC-E-4-EV	4362	CPF150PC-E-4	4300	CPB100JC-E-4-EV	6884	CPB100PC-E-0	8800
QOD87614	CPF200JC-E-4-EV	6350	N/A	N/A	CPB100JC-E-4-EV	6884	CPB100PC-E-0	8800
QOD8788	CPF150JC-E-4-EV	4362	CPF150PC-E-4	4300	CPB075JC-E-4-EV	5802	CPB075PC-E-0	6700
QOD87810	CPF150JC-E-4-EV	4362	CPF150PC-E-4	4300	CPB100JC-E-4-EV	6884	CPB100PC-E-0	8800
QOD87812	CPF200JC-E-4-EV	6350	N/A	N/A	CPB100JC-E-4-EV	6884	CPB100PC-E-0	8800
QOD87814	CPF200JC-E-4-EV	6350	N/A	N/A	CPB100JC-E-4-EV	6884	CPB100PC-E-0	8800

*BTUH calculated using 16 hour design runtimes on coolers and 20 hour design runtimes on freezers

**Contact factory for information.

REFRIGERATION SYSTEM PHYSICAL SPECIFICATIONS

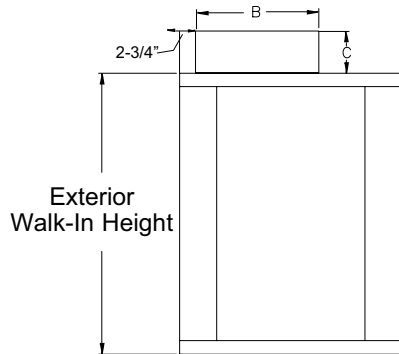

Side View

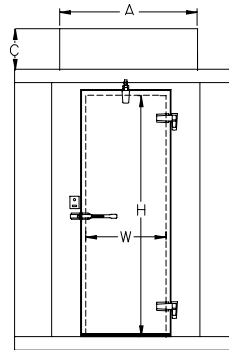

Front View

DOOR OPENING SIZE		
W	H	MODEL
26"	66"	STD Series
26"	78"	74 Series
26"	78"	77 Series

CAPSULE PAK™ MODEL NO.	"A"	"B"	"C"
CPB050JC-*0-EV	41-1/8"	50-1/2"	20-5/8"
CPB075JC-*4-EV	41-1/8"	50-1/2"	20-5/8"
CPB100JC-*4-EV	41-1/8"	50-1/2"	20-5/8"
CPF060JC-*4-EV	41-1/8"	50-1/2"	20-5/8"
CPF075JC-*4-EV	41-1/8"	50-1/2"	20-5/8"
CPF100JC-*4-EV	41-1/8"	50-1/2"	20-5/8"
CPF150JC-*4-EV	45-3/4"	53-3/8"	24-3/4"
CPF200JC-*4-EV	45-3/4"	53-3/8"	24-3/4"

CAPSULE PAK ECO™ MODEL NO.	"A"	"B"	"C"
CPB050PC-*0	36-3/4"	48-1/4"	14-7/8"
CPB075PC-*0	36-3/4"	48-1/4"	14-7/8"
CPB100PC-*0	36-3/4"	48-1/4"	18-7/8"
CPF050PC-*0	36-3/4"	48-1/4"	14-7/8"
CPF075PC-*0	36-3/4"	48-1/4"	14-7/8"
CPF100PC-*0	36-3/4"	48-1/4"	18-7/8"
CPF150PC-*4	36-3/4"	48-1/4"	18-7/8"

* Insert "S" for indoor model and "E" for outdoor

NOTE:

- Consideration must be given to accessibility for service & free condenser air flow. Consult factory with installation questions. Proper condensing unit ventilation must be provided. The factory recommends 200cfm of fresh air in the surrounding area with ample clearance around the condensing unit.
- +90°F ambient or less and 50% RH
- Subject to change without notice

REFRIGERATION SYSTEM TECHNICAL DATA
CAPSULE PAK™ INDOOR REFRIGERATION SYSTEMS (CORD AND PLUG CONNECTED)

MODEL	REFRIGERANT	REFRIGERANT CHARGE (OZ)	ELECTRICAL	TOTAL SYSTEM AMPS	TOTAL DEFROST AMPS	NEMA PLUG	AWEF	BTUH*	SHIP WT. (LB/KG)
CPB050JC-S-0-EV	R-449A	80	115/60/1	6.3	N/A	5-15P	5.61	4400	261/118
CPB075JC-S-4-EV	R-449A	80	208-230/60/1	5.6	N/A	6-15P	5.61	6366	271/123
CPB100JC-S-4-EV	R-449A	80	208-230/60/1	7.5	N/A	6-15P	5.61	7300	275/125
CPF060JC-S-4-EV	R-449A	80	208-230/60/1	8.0	5.7	6-15P	1.99	2250	270/122
CPF075JC-S-4-EV	R-449A	80	208-230/60/1	8.5	5.7	6-15P	2.08	3130	271/123
CPF100JC-S-4-EV	R-449A	80	208-230/60/1	9.6	5.7	6-15P	2.11	3500	275/125
CPF150JC-S-4-EV	R-449A	80	208-230/60/1	13.7	8.7	6-20P	2.22	4509	358/162
CPF200JC-S-4-EV	R-449A	96	208-230/60/1	14.8	8.7	6-20P	2.43	6725	377/171

CAPSULE PAK™ OUTDOOR REFRIGERATION SYSTEMS (CORD AND PLUG CONNECTED)

MODEL	REFRIGERANT	REFRIGERANT CHARGE (OZ)	ELECTRICAL	TOTAL SYSTEM AMPS	TOTAL DEFROST AMPS	NEMA PLUG	AWEF	BTUH*	SHIP WT. (LB/KG)
CPB050JC-E-0-EV	R-449A	80	115/60/1	6.3	N/A	5-15P	7.60	4115	286/130
CPB075JC-E-4-EV	R-449A	80	208-230/60/1	5.6	N/A	6-15P	7.60	5802	296/134
CPB100JC-E-4-EV	R-449A	80	208-230/60/1	7.5	N/A	6-15P	7.60	6884	300/136
CPF060JC-E-4-EV	R-449A	80	208-230/60/1	8.0	5.7	6-15P	2.89	2135	285/129
CPF075JC-E-4-EV	R-449A	80	208-230/60/1	8.5	5.7	6-15P	2.92	2875	285/129
CPF100JC-E-4-EV	R-449A	80	208-230/60/1	9.6	5.7	6-15P	2.95	3210	295/134
CPF150JC-E-4-EV	R-449A	128	208-230/60/1	13.7	8.7	6-20P	3.03	4362	378/171
CPF200JC-E-4-EV	R-449A	128	208-230/60/1	14.8	8.7	6-20P	3.15	6350	397/180

CAPSULE PAK ECO™ INDOOR REFRIGERATION SYSTEMS (CORD AND PLUG CONNECTED)

MODEL	REFRIGERANT	REFRIGERANT CHARGE (OZ)	ELECTRICAL	TOTAL SYSTEM AMPS	NEMA PLUG	AWEF	BTUH*	SHIP WT. (LB/KG)
CPB050PC-S-0	R290	5.25	115/60/1	6.9	5-15P	5.61	4100	192/87
CPB075PC-S-0	R290	9.5	115/60/1	11.4	5-20P	5.61	6700	214/97
CPB100PC-S-0	R290	10.5	115/60/1	15.3	5-20P	5.61	8800	257/117
CPF050PC-S-0	R290	5.25	115/60/1	6.9	5-15P	1.96	1600	197/89
CPF075PC-S-0	R290	9.5**	115/60/1	11.4	5-20P	2.07	2900	219/99
CPF100PC-S-0	R290	10.5***	115/60/1	15.3	5-20P	2.14	3600	262/119
CPF150PC-S-4	R290	10.5***	230/60/1	7.4	6-15P	2.21	4400	262/119

CAPSULE PAK ECO™ OUTDOOR REFRIGERATION SYSTEMS (CORD AND PLUG CONNECTED)

MODEL	REFRIGERANT	REFRIGERANT CHARGE (OZ)	ELECTRICAL	TOTAL SYSTEM AMPS	NEMA PLUG	AWEF	BTUH*	SHIP WT. (LB/KG)
CPB050PC-E-0	R290	5.25	115/60/1	6.9	5-15P	7.6	4100	206/93
CPB075PC-E-0	R290	9.5	115/60/1	11.4	5-20P	7.6	6700	228/103
CPB100PC-E-0	R290	10.5	115/60/1	15.3	5-20P	7.6	8800	271/123
CPF050PC-E-0	R290	5.25	115/60/1	6.9	5-15P	2.84	1600	211/95
CPF075PC-E-0	R290	9.5**	115/60/1	11.4	5-20P	2.91	2900	233/105
CPF100PC-E-0	R290	10.5***	115/60/1	15.3	5-20P	2.96	3600	276/125
CPF150PC-E-4	R290	10.5***	230/60/1	7.4	6-15P	3.01	4400	276/125

*BTUH calculated using 90°F ambient.
 **Two compressors using 4.75 oz each.
 ***Two compressors using 5.25 oz each.

Note:

- Consult factory for application specifics
- All Capsule Pak and Capsule Pak ECO systems require a single power supply.



Capsule Pak Models

9 ft. long power cord attached to condensing unit section

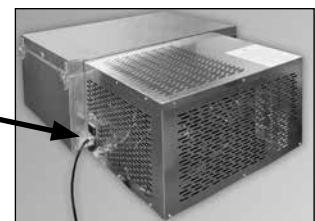

Capsule Pak ECO Models

CAPSULE PAK™ REMOTE SYSTEMS (ALL WITH R-449A REFRIGERANT)



Evaporator section located on top of walk-in.

Condensing unit section remotely located.

Outdoor systems include ambient controls and weather-proof hoods with quick connects for simple field connections to pre-charged line lengths available in 5' increments up to 50' maximum. Wiring harnesses are also available and must be ordered by length (50' maximum).

Consult factory for application specifics, pricing, and ship date availabilities.

MODEL	REFRIGERANT	VOLTAGE	SYSTEM MCA	SYSTEM MAX. FUSE	AWEF	BTUH*	SHIP WT. (LB/KG)
COOLER MODELS							
CPB050JC-R-0-EV	R-449A	115/60/1	13.5	20	7.6	4394	270/122
CPB075JC-R-4-EV	R-449A	208-230/60/1	9.7	15	7.6	5729	285/129
CPB100JC-R-4-EV	R-449A	208-230/60/1	10.4	15	7.6	7300	285/129
FREEZER MODELS							
CPF060JC-R-4-EV	R-449A	208-230/60/1	8.9	15	2.9	2591	275/125
CPF075JC-R-4-EV	R-449A	208-230/60/1	9.7	15	2.93	3167	290/131
CPF100JC-R-4-EV	R-449A	208-230/60/1	11.2	15	2.94	3532	290/131
CPF150JC-R-4-EV	R-449A	208-230/60/1	17.1	20	3.03	4811	375/170
CPF200JC-R-4-EV	R-449A	208-230/60/1	17.6	30	3.13	6313	375/170

Note: Electrical specification intended to be single point connection (including electrical harness). All remote Capsule Pak systems require one power supply and include an electrical harness to connect the condensing unit and evaporator sections.

*BTUH calculated using 90°F ambient.

Optional Electric Condensate Vaporizer

Capsule Pak Remote Systems are available with an electric condensate vaporizer. This UL and C-UL approved product requires no drain lines on indoor applications, which makes installation fast and easy and allows equipment to be operational in a shorter time frame.

NOTE: All specifications within this publication subject to change without notice.