

QS SERIES

Walk-In Coolers & Freezers With Self-Contained Refrigeration Systems



FEATURES

- Cooler or freezer models
- Sizes from 4' x 6' to 10' x 14'
- Three heights: 6'7" & 7'7" with floor; 7'4" floorless
- Door width options: 26", 30" or 36"
- Indoor or outdoor models
- Two temperatures: +37°F, -10°F
- Ceiling mount Capsule Pak ECO refrigeration system (ordered separately)
- Air-cooled condensing unit
- LogiTemp® electronic controller system
- 26 gauge corrosion resistant stucco embossed coated steel on all surfaces except interior floor
- Smooth aluminum interior floor (on models with floor)
- Floorless models supplied with NSF listed vinyl sealers
- Full 4" thick panels foamed-in-place with EPA-compliant polyurethane insulation
- Heavy duty adjustable cam-lift hinges
- Spring actuated door closer
- Deadbolt locking handle with independent key/padlock feature and inside safety release
- Magnetic gasket
- Digital thermometer and light switch
- Floor double sweep gasket
- Perimeter door heater wire
- High output low profile LED light positioned above the door to prevent interference with shelving or product
- UL and C-UL listing on complete Capsule Pak ECO refrigeration systems*
- UL NCKL listed certifying compliant walk-ins are ignition protected
- NSF listed, UL flame spread 25 or less on all foam cores; UL electrical listing on door sections
- City of Houston listed
- California State listed
- CN UL flame spread listed
- DOE compliant
- Oregon State listed
- USDA accepted
- 15 year panel warranty
- 18 months parts & labor warranty
- Indoor models feature hot gas or wick condensate vaporizer
- Outdoor models:
 - White membrane roof and trim
 - -20°F ambient controls
 - Outdoor cooler models with Capsule Pak ECO refrigeration systems feature a heater to prevent product loss in low ambient conditions

Equipped with
**SELF-CONTAINED
 CAPSULE PAK ECO™**
 Refrigeration Systems
 Featuring R290 Refrigerant



OPTIONS

(Most options available two weeks from receipt of order. Please contact us for specific questions.)

- Heights: 8'7" with floor, 8'4" without floor
- U-shaped shelving system
- Floor tread plate kit
- Exterior ramp
- Door hood (outdoor models)
- Heater kit for outdoor use with medium temp applications where ambient conditions may go below 32°F
- Leak detector/alarm (may be a requirement in some areas)
- Electric vaporizer (indoor models only)
- Five year compressor warranty

* C-UL is Underwriters Laboratories Safety Certification Mark which indicates that UL has tested the equipment to applicable CSA Standards.

WALK-IN SPECIFICATIONS

QS Series walk-ins are built of modular panels and are insulated with foamed-in-place EPA-compliant polyurethane insulation. Each panel is designed to ensure ease of installation, long term reliability and high insulating efficiency.

A. All panels are manufactured with male and female mating rails to ensure proper alignment during installation. The polyurethane insulation wraps around the return bend metal seams on both section to create a lightweight panel of exceptional strength and durability. All panels are a full four (4) inches thick and provide a superior insulating value.

B. The foamed-in-place cam locking fasteners ensure an airtight seal for maximum energy efficiency.

C. Panel gaskets located around the outer perimeter of the panel are continuous, without cuts or breaks at corners. Because gaskets are foamed-in-place as an integral part of the panel, they cannot fall off or pull off during shipment or installation.

D. Panels lock together tightly for an energy efficient walk-in.

E. Edge caps for ends of floor and ceiling panels are foamed-in-place rather than overlapped or mechanically fastened. Edge caps cannot come loose, and they stay in place through the life of the walk-in.

F. Panel Finishes: Interior and exterior panels are fabricated with 26 gauge corrosion resistant stucco embossed coated steel. Models supplied with a floor will include a smooth aluminum interior floor surface.

G. Insulation: Panels are four (4) inches thick, metal clad and foamed-in-place with HFO polyurethane insulation which is HFC free.

The minimum R-values for 4" HFO panels are:

Cooler:

Walls/Ceilings R-value 25

Doors R-value 25

Freezer:

Walls/Ceilings R-value 32

Doors R-value 32

Floors R-value 28

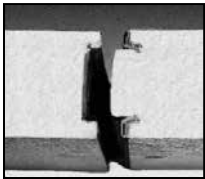

A.

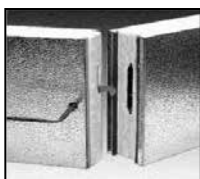

B.

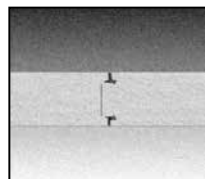

C.

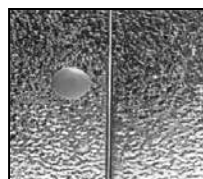

D.

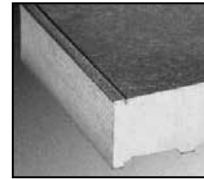

E.

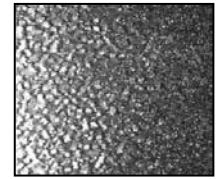

F.

AVAILABLE SIZES

The Standard Series of QS Series walk-ins are all 6'-7" high and are all supplied with a floor. The sizes available are as follows: 4' wide x 6' long, 6' wide x 6' long, 6' wide x 8' long, 6' wide x 10' long, 6' wide x 12' long, 8' wide x 8' long, and 8' wide x 10' long.

The 77 Series of QS Series walk-ins are all 7'-7" high and are all supplied with a floor. The sizes available are as follows: 6' wide x 6' long, 6' wide x 8' long, 6' wide x 10' long, 6' wide x 12' long, 8' wide x 8' long, and 8' wide x 10' long.

The 74 Series of QS Series walk-ins are all 7'-3⁵/₈" high and are all supplied without a floor. Wall panels are installed on top of NSF listed vinyl sealers provided. The sizes available are as follows: 6' wide x 6' long, 6' wide x 8' long, 6' wide x 10' long, 6' wide x 12' long, 8' wide x 8' long, and 8' wide x 10' long.

OUTDOOR MODELS

All QS Series walk-ins installed outdoors include a weather protection kit consisting of: One piece, 35 mill, white membrane roof material which requires no seaming or gluing to the top of the QS Series walk-in ceiling panels.

Metal trim for flashing the membrane roof material to the side of the QS Series walk-in wall panels is included.

Trim is secured to the QS Series wall panels with self-drilling and self-tapping TEK screws. In applications where the QS Series walk-in is installed next to a building, the trim can be used to secure the turned up membrane roof material to the building wall, with fasteners supplied. Door rain hoods are an option and should be included on installations where the door panels are exposed to the outdoor weather.

DOOR

Door sections are factory tested to assure proper fit, performance and alignment. All doors feature a stepped profile design that serves as a barrier to air flow which results in an energy efficient door system. Door sections are 4" thick, metal clad and foamed-in-place with EPA-compliant polyurethane insulation.

Each QS Series walk-in compartment is equipped with a 26" wide door opening. The height of the door opening varies with the series of walk-in ordered. The Standard Series (6'7" high) has a 66" high door opening and the 74 and 77 Series walk-ins have a 78" high door opening. The door is self-closing, flush mounted, infitting and constructed to incorporate heavy duty, molded ABS breaker which is permanently foamed-in-place.

Doors are available with right or left side hinges and include two field adjustable cam-lift hinges with locking set screw, top hinge spring loaded, spring actuated door closer, NL 9800 deadbolt locking handle with independent key/padlock feature and inside safety release. The doors are pre-hung in a four foot wide frame panel which is equipped with replaceable perimeter heater wire, magnetic stainless steel trim, digital thermometer, vapor proof LED light fixture and switch with exterior pilot indicator light.

The door section is completely pre-wired within concealed conduit inside the door frame panel. 120/60/1 electrical is field wired to a junction box which is surface mounted next to the interior frame above the vapor proof LED light fixture.

Hinges and door handle are mounted to heavy-duty tapping plates. Each door section is complete with a fiberglass reinforced plastic heated threshold.

DOOR OPENING SIZE		
W	H	MODEL
26"	66"	STD Series
26"	78"	74 Series
26"	78"	77 Series

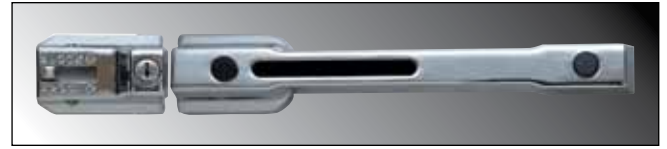

Deadbolt-locking handle



Spring actuated door closer



LED light fixture

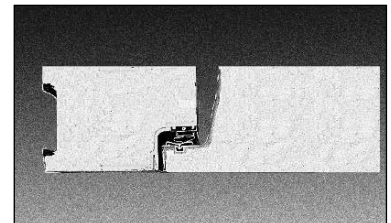

Doors feature a stepped profile design



Digital thermometer/light switch

These doors are designed and certified for use in walk-in cooler applications.

DOOR MODEL NUMBER	ENERGY CONSUMPTION (KWH/DAY)	DOOR SURFACE AREA (SQ. FT.)	ELECTRICAL	WATTS	AMPS
QS26X66	2.37	13.40	120/60/1	100.80	0.84
QS26X78	2.49	15.80	120/60/1	106.07	0.88

These doors are designed and certified for use in walk-in freezer applications.

DOOR MODEL NUMBER	ENERGY CONSUMPTION (KWH/DAY)	DOOR SURFACE AREA (SQ. FT.)	ELECTRICAL	WATTS	AMPS
QS26X66	6.68	13.40	120/60/1	196.07	1.63
QS26X78	7.01	15.80	120/60/1	207.07	1.73

FLOOR CONSTRUCTION

Floor panels (when supplied) are similar in construction to the wall panels except they are made to withstand uniformly distributed floor loads of up to 800 pounds per square foot. The interior floor metal is smooth aluminum.

The 74 Series, floorless models, are supplied with a patented vinyl floor sealer to stop conductivity at floor level. This unique sealer sits flat on existing floors and fits tightly against the interior/ exterior wall panels. The walk-in wall panel is supported on the shoulder of the sealer so the foam edge is free of compressing weight. The vinyl floor sealer is NSF listed.

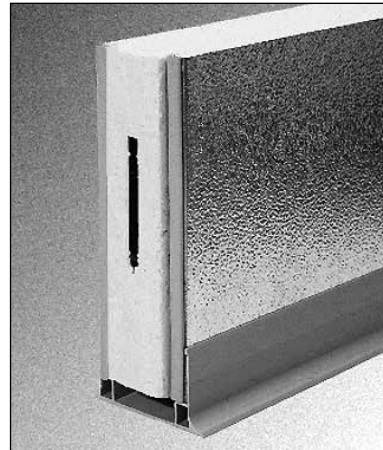

Floorless models are supplied with a patented vinyl floor sealer

SHELVING KITS

Shelving kits specifically designed for each QS Series walk-in configuration are offered as an optional extra. These kits are shipped with the QS Series walk-in and Capsule Pak ECO™ refrigeration system so that all necessary components are at your location promptly when you need them. The shelving sets are coded to correspond to the QS Series walk-in configuration ordered and are offered in either three or four tier.



Shelving system types include Green Kote™ and Chrome Kote™

SHELVING SYSTEM TYPES

A. Green Kote™ Shelving: Electrostatically applied green baked epoxy over zinc steel and brite basic wire. Thickness: 2-3 mill. 15 year guarantee against corrosion.

B. Standard Chrome Kote™ Shelving: Plated quality wire and steel. Surface nickel chrome plated.

Select the shelving finish of your choice. Shelving posts are engineered for maximum strength. Shelves are adjustable on 2" centers. All shelves are NSF listed and are zinc coated with a heavy layer of Protoxy for a maximum life span under humid storage conditions. Special clips are utilized to gain the maximum square footage of storage space for each QS Series model. 14", 18" and 24" wide shelves are used as required for maximum storage capacity in each set. This wire shelving is ideal for storage of all refrigerated or frozen products.

SHELVES

Shelves to have #9 (.148") ga. crosswires spaced 3/4" on centers with crossbraces 1/4" (.192") minimum of 4-3/4" on center.

- **Shelf Frames:** Channel to be 9/16" x 1" x .075" thick.
- **Shelf Collars:** A round tapered 1-5/16" high steel collar to be welded at each corner.

POSTS

Posts to be .062" thick 1" O.D. round tubing notched every 2" on each corner of the post.

POST LEVELERS

Installed on the bottom of each post is nylon housing for a steel leveler 3/8"-16 x 1-3/4".

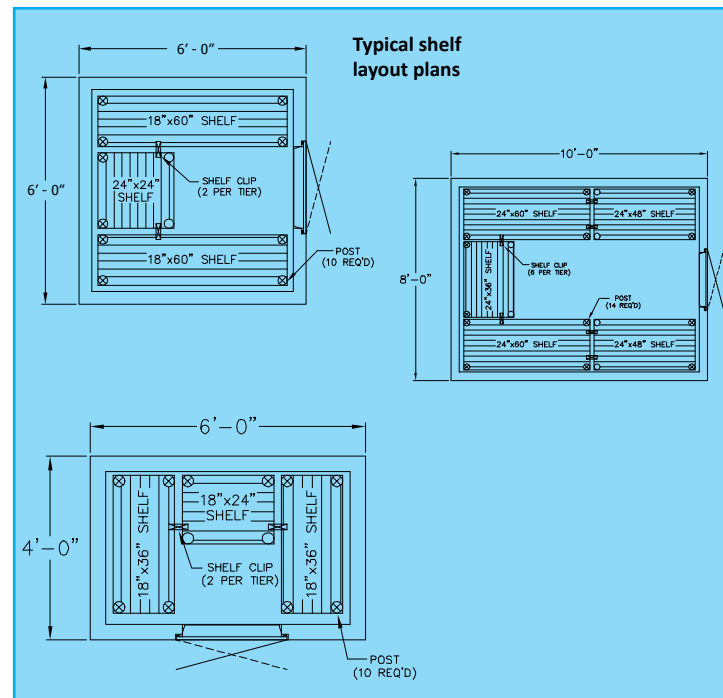

STANDARD SELF-CONTAINED REFRIGERATION SYSTEMS



Indoor System



Outdoor System



R290
ECO-FRIENDLY
NATURAL REFRIGERANT



PATENTED
TECHNOLOGY
U.S. Patent No. 11,859,885

FEATURES

- Condensing unit and evaporator coil contained in a single housing ready to mount on top of your Master-Bilt walk-in
- Indoor and outdoor ceiling mount models
- Available for coolers or freezers
- Systems may be specified for walk-in rooms 14' long and under (excluding 10' x 14' freezers)
- Two temperatures: +37°F and -10°F
- Air cooled condensing unit
- Automatic condensate evaporator on indoor systems
- LogiTemp® electronic controller system
- Electronic control provided for automatic defrost on both coolers and freezers
- All models feature standard cord and plug eliminating the need for field connection
- Outdoor coolers incorporate a patent pending heater design for low ambient conditions to keep walk-in temperatures at the set point
- UL and C-UL electrical listing on complete Capsule Pak ECO refrigeration systems*
- DOE, CARB and SNAP compliant
- 18 months parts and labor warranty (optional 5 year compressor warranty available)

STANDARD LOGITEMP® ELECTRONIC CONTROLLER



- More precise and reliable temperature control compared to all-mechanical systems
- Digital readout and four button overlay for easy setup and navigation
- Demand Defrost technology that initiates defrosts only as needed for further energy savings (optional on Capsule Pak ECO cooler models)
- LogiTemp provides online data for instant notification of error codes and settings (standard feature on outdoor systems, optional on indoor)

* C-UL is Underwriters Laboratories Safety Certification Mark which indicates that UL has tested the equipment to applicable CSA Standards.

CAPSULE PAK ECO™ REFRIGERATION SYSTEM SPECIFICATIONS

Capsule Pak ECO™ refrigeration systems consist of a single assembly pre-charged condensing unit and evaporator coil factory assembled, wired, tested and ready for insertion into a factory prepared walk-in ceiling opening. All systems are UL and C-UL listed and DOE compliant.

Capsule Pak ECO systems are ceiling mount and available for indoor or outdoor installations. Models are available for interior compartment design temperatures of +37°F and -10°F. Installation is fast and easy with no plumbing required on indoor units.

A flush evaporator coil keeps all components outside the walk-in storage area allowing more storage inside. The

evaporator enclosure is constructed utilizing foamed-in-place polyurethane insulation and equipped with a removable, gasketed access cover. High efficiency EC evaporator fan motors circulate air throughout the walk-in.

Indoor Capsule Pak ECO models incorporate a condensate pan with wicking pads and forced air from the condenser fan to evaporate condensate. Outdoor models feature crankcase heaters for low ambient conditions.

Note: Allow minimum of 4" clearance above and 24" on each side of the system for installation. Consideration should be given to accessibility for service and free condenser air flow. Consult factory with installation questions.

050 & 075 MODELS

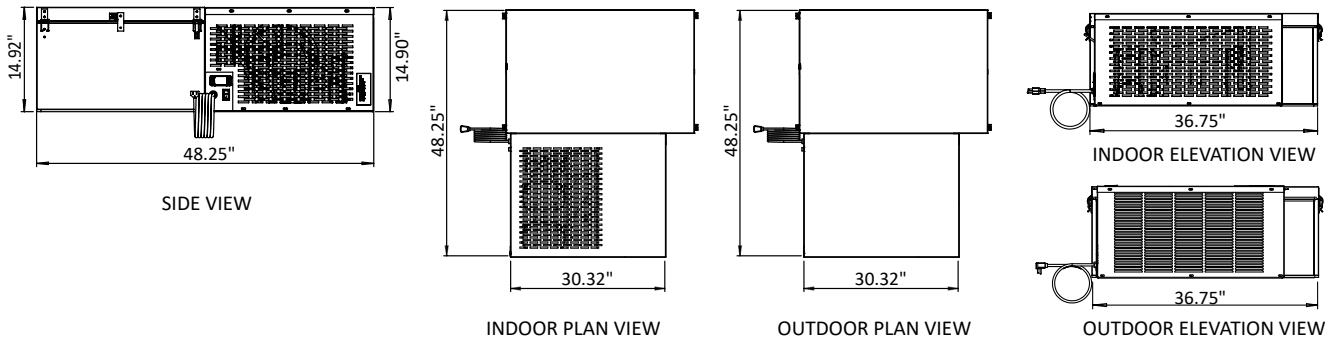

100, 150 & 175 MODELS

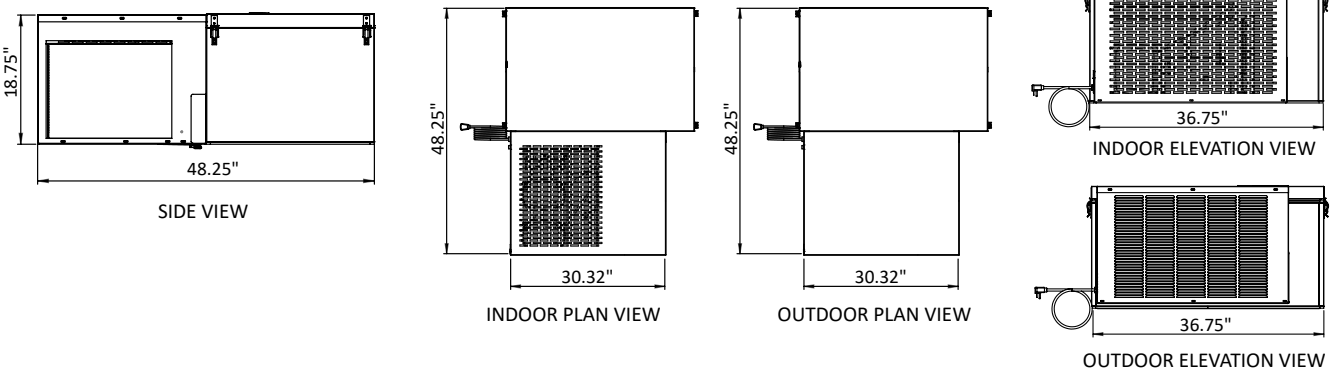

NOTE:

- Consideration must be given to accessibility for service and free condenser air flow. Consult factory with installation questions.
- Proper condensing unit ventilation must be provided. The factory recommends 200cfm of fresh air in the surrounding area with ample clearance around the condensing unit.
- Subject to change without notice.

FLOOR PLAN LAYOUTS FOR SINGLE ROOM COOLERS OR FREEZERS

Model numbers indicate the door location on the standard QS Series layouts

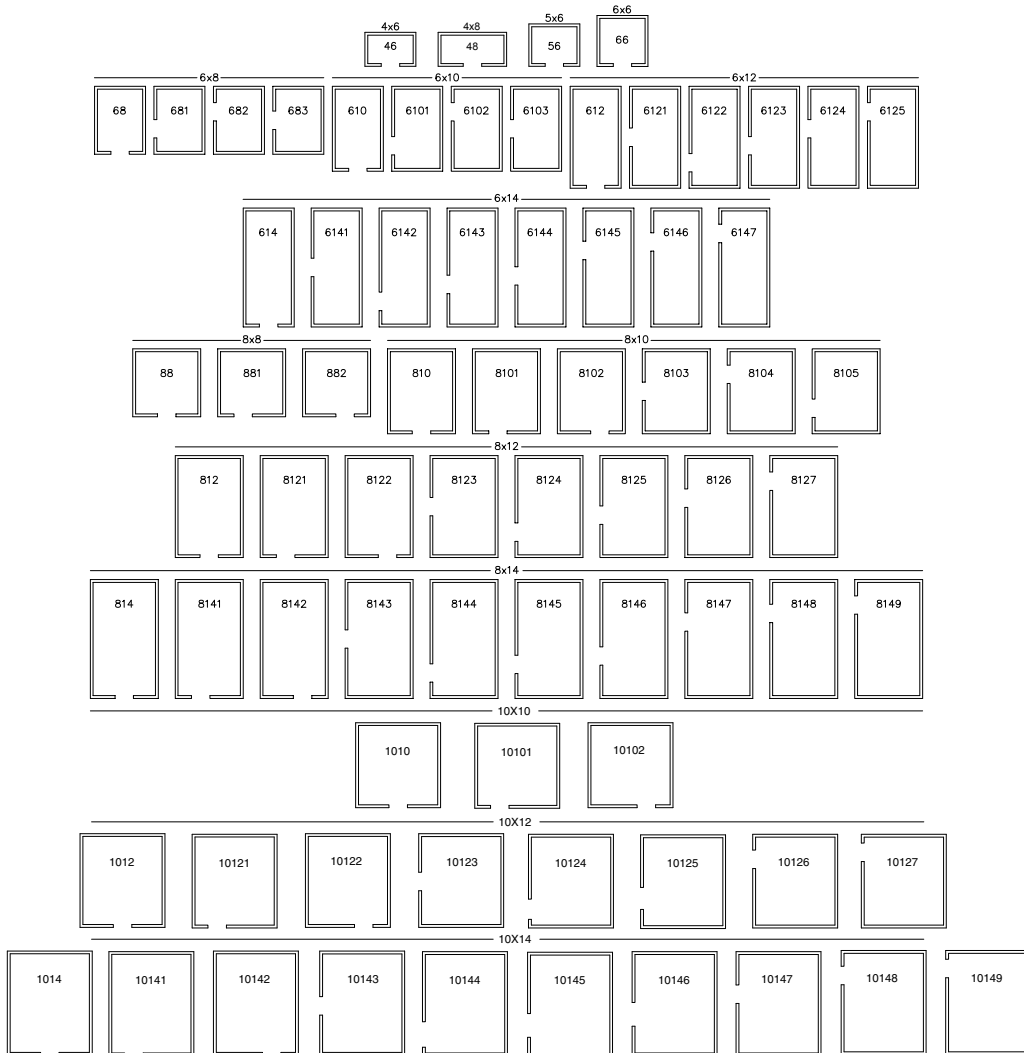

PHYSICAL SPECIFICATIONS

6'7" HIGH		7'4" HIGH & 7'7" HIGH	
MODEL	CAPACITY CU. FT.	MODEL	CAPACITY CU. FT.
QS46 (4' x 6')	105	QS7746	123
QS56 (5' x 6')	137	QS7756	159
QS66 (6' x 6')	168	QS7766	196
QS68 (6' x 8')	231	QS7768	270
QS610 (6' x 10')	295	QS77610	344
QS612 (6' x 12')	357	QS77612	418
QS614 (6' x 14')	420	QS77614	490
QS88 (8' x 8')	318	QS7788	372
QS810 (8' x 10')	404	QS77810	473
QS812 (8' x 12')	490	QS77812	574
QS814 (8' x 14')	578	QS77814	675
QS1010 (10' x 10')	515	QS771010	602
QS1012 (10' x 12')	625	QS771012	731
QS1014 (10' x 14')	736	QS771014	860

MATCHING REFRIGERATION SYSTEMS

QS SERIES MODEL	SELF-CONTAINED ONE-PIECE CEILING MOUNT			
	-10°F, 90° AMBIENT		+37°F to +38°F, 90° AMBIENT	
	CAPSULE PAK ECO™ MODEL	BTUH*	CAPSULE PAK ECO™ MODEL	BTUH*
6'7" HIGH WITH FLOOR				
QS46	CPF050PC-S-0	1600	CPB050PC-S-0	4100
QS56	CPF075PC-S-0	2900	CPB050PC-S-0	4100
QS66	CPF075PC-S-0	2900	CPB050PC-S-0	4100
QS68	CPF100PC-S-0	3600	CPB050PC-S-0	4100
QS610	CPF100PC-S-0	3600	CPB075PC-S-0	6700
QS612	CPF150PC-S-4	4400	CPB075PC-S-0	6700
QS614	CPF175PC-S-4	6350	CPB075PC-S-0	6700
QS88	CPF150PC-S-4	4400	CPB075PC-S-0	6700
QS810	CPF150PC-S-4	4400	CPB075PC-S-0	6700
QS812	CPF175PC-S-4	6350	CPB075PC-S-0	6700
QS814	CPF175PC-S-4	6350	CPB075PC-S-0	6700
QS1010	CPF175PC-S-4	6350	CPB075PC-S-0	6700
QS1012	CPF175PC-S-4	6350	CPB075PC-S-0	6700
QS1014	N/A**	N/A**	CPB100PC-S-0	8800
6'7" HIGH WITH FLOOR OUTDOOR				
QOD46	CPF100PC-E-0	3600	CPB050PC-E-0	4100
QOD56	CPF100PC-E-0	3600	CPB050PC-E-0	4100
QOD66	CPF100PC-E-0	3600	CPB050PC-E-0	4100
QOD68	CPF150PC-E-4	4300	CPB050PC-E-0	4100
QOD610	CPF175PC-E-4	6300	CPB075PC-E-0	6700
QOD612	CPF175PC-E-4	6300	CPB075PC-E-0	6700
QOD614	CPF175PC-E-4	6300	CPB075PC-E-0	6700
QOD88	CPF175PC-E-4	6300	CPB075PC-E-0	6700
QOD810	CPF175PC-E-4	6300	CPB075PC-E-0	6700
QOD812	CPF175PC-E-4	6300	CPB075PC-E-0	6700
QOD814	CPF175PC-E-4	6300	CPB075PC-E-0	6700
QOD1010	CPF175PC-E-4	6300	CPB075PC-E-0	6700
QOD1012	CPF175PC-E-4	6300	CPB075PC-E-0	6700
QOD1014	N/A**	N/A**	CPB100PC-E-0	8800
7' 4" HIGH LESS FLOOR - INDOOR ONLY				
QS7446	N/A	N/A	CPB050PC-S-0	4100
QS7456			CPB050PC-S-0	4100
QS7466			CPB050PC-S-0	4100
QS7468			CPB050PC-S-0	4100
QS74610			CPB075PC-S-0	6700
QS74612			CPB075PC-S-0	6700
QS74614			CPB075PC-S-0	6700
QS7488			CPB075PC-S-0	6700
QS74810			CPB075PC-S-0	6700
QS74812			CPB075PC-S-0	6700
QS74814			CPB075PC-S-0	6700
QS741010			CPB100PC-S-0	8800
QS741012			CPB100PC-S-0	8800
QS741014			CPB100PC-S-0	8800

*BTUH calculated using 16 hour design runtimes on coolers and 20 hour design runtimes on freezers.

**10x14 freezer models ship with a remote Split-Pak™ refrigeration system and require additional installation.

MATCHING REFRIGERATION SYSTEMS

QS SERIES MODEL	SELF-CONTAINED ONE-PIECE CEILING MOUNT			
	-10°F, 90°F AMBIENT		+37°F to +38°F, 90°F AMBIENT	
	CAPSULE PAK ECO™ MODEL	BTUH*	CAPSULE PAK ECO™ MODEL	BTUH*
7' 7" HIGH WITH FLOOR				
QS7746	CPF050PC-S-0	1600	CPB050PC-S-0	4100
QS7748	CPF075PC-S-0	2900	CPB050PC-S-0	4100
QS7756	CPF075PC-S-0	2900	CPB050PC-S-0	4100
QS7766	CPF075PC-S-0	2900	CPB050PC-S-0	4100
QS7768	CPF100PC-S-0	3600	CPB050PC-S-0	4100
QS77610	CPF100PC-S-0	3600	CPB075PC-S-0	6700
QS77612	CPF150PC-S-4	4400	CPB075PC-S-0	6700
QS77614	CPF150PC-S-4	4400	CPB075PC-S-0	6700
QS7788	CPF175PC-S-4	6350	CPB075PC-S-0	6700
QS77810	CPF175PC-S-4	6350	CPB075PC-S-0	6700
QS77812	CPF175PC-S-4	6350	CPB075PC-S-0	6700
QS77814	CPF175PC-S-4	6350	CPB100PC-S-0	8800
QS771010	CPF175PC-S-4	6350	CPB100PC-S-0	8800
QS771012	CPF175PC-S-4	6350	CPB100PC-S-0	8800
QS771014	N/A**	N/A**	CPB100PC-S-0	8800
7' 7" HIGH WITH FLOOR OUTDOOR				
QOD7746	CPF100PC-E-0	3600	CPB050PC-E-0	4100
QOD7756	CPF100PC-E-0	3600	CPB050PC-E-0	4100
QOD7766	CPF100PC-E-0	3600	CPB050PC-E-0	4100
QOD7768	CPF150PC-E-4	4300	CPB050PC-E-0	4100
QOD77610	CPF175PC-E-4	6300	CPB075PC-E-0	6700
QOD77612	CPF175PC-E-4	6300	CPB075PC-E-0	6700
QOD77614	CPF175PC-E-4	6300	CPB075PC-E-0	6700
QOD7788	CPF175PC-E-4	6300	CPB075PC-E-0	6700
QOD77810	CPF175PC-E-4	6300	CPB075PC-E-0	6700
QOD77812	CPF175PC-E-4	6300	CPB075PC-E-0	6700
QOD77814	CPF175PC-E-4	6300	CPB100PC-E-0	8800
QOD771010	CPF175PC-E-4	6300	CPB075PC-E-0	6700
QOD771012	CPF175PC-E-4	6300	CPB075PC-E-0	6700
QOD771014	N/A**	N/A**	CPB100PC-E-0	8800
8'4" HIGH LESS FLOOR				
QS8466	N/A	N/A	CPB050PC-S-0	4100
QS8468			CPB050PC-S-0	4100
QS84610			CPB075PC-S-0	4100
QS84612			CPB075PC-S-0	6700
QS84614			CPB075PC-S-0	6700
QS8488			CPB075PC-S-0	6700
QS84810			CPB075PC-S-0	6700
QS84812			CPB100PC-S-0	8800
QS84814			CPB100PC-S-0	8800
8'7" HIGH WITH FLOOR				
QS8766	CPF075PC-S-0	2900	CPB050PC-S-0	4100
QS8768	CPF100PC-S-0	3600	CPB050PC-S-0	4100
QS87610	CPF100PC-S-0	3600	CPB075PC-S-0	6700
QS87612	CPF150PC-S-4	4400	CPB075PC-S-0	6700
QS87614	CPF175PC-S-4	6350	CPB075PC-S-0	6700
QS8788	CPF150PC-S-4	4400	CPB075PC-S-0	6700
QS87810	CPF150PC-S-4	4400	CPB075PC-S-0	6700
QS87812	CPF175PC-S-4	6350	CPB100PC-S-0	8800
QS87814	CPF175PC-S-4	6350	CPB100PC-S-0	8800
8'7" HIGH WITH FLOOR OUTDOOR				
QOD8766	CPF100PC-E-0	3600	CPB050PC-E-0	4100
QOD8768	CPF150PC-E-4	4300	CPB050PC-E-0	4100
QOD87610	CPF175PC-E-4	6300	CPB075PC-E-0	6700
QOD87612	CPF175PC-E-4	6300	CPB075PC-E-0	6700
QOD87614	CPF175PC-E-4	6300	CPB075PC-E-0	6700
QOD8788	CPF175PC-E-4	6300	CPB075PC-E-0	6700
QOD87810	CPF175PC-E-4	6300	CPB075PC-E-0	6700
QOD87812	CPF175PC-E-4	6300	CPB075PC-E-0	6700
QOD87814	CPF175PC-E-4	6300	CPB075PC-E-0	6700

*BTUH calculated using 16 hour design runtimes on coolers and 20 hour design runtimes on freezers

**10x14 freezer models ship with a remote Split-Pak™ refrigeration system and require additional installation.

REFRIGERATION SYSTEM TECHNICAL DATA

CAPSULE PAK ECO™ INDOOR REFRIGERATION SYSTEMS (CORD AND PLUG CONNECTED)

MODEL	REFRIGERANT	REFRIGERANT CHARGE (OZ)	ELECTRICAL	TOTAL SYSTEM AMPS	NEMA PLUG	AWEF	BTUH*	SHIP WT. (LB/KG)
CPB050PC-S-0	R290	5.25	115/60/1	6.9	5-15P	5.61	4100	192/87
CPB075PC-S-0		9.5**	115/60/1	11.4	5-20P	5.61	6700	214/97
CPB100PC-S-0		10.5***	115/60/1	15.3	5-20P	5.61	8800	257/117
CPF050PC-S-0		5.25	115/60/1	6.9	5-15P	1.96	1600	197/89
CPF075PC-S-0		9.5**	115/60/1	11.4	5-20P	2.07	2900	219/99
CPF100PC-S-0		10.5***	115/60/1	15.3	5-20P	2.14	3600	262/119
CPF150PC-S-4		10.5***	230/60/1	7.4	6-15P	2.21	4400	262/119
CPF175PC-S-4		10.5***	230/60/1	10.7	6-15P	2.38	6350	375/170

CAPSULE PAK ECO™ OUTDOOR REFRIGERATION SYSTEMS (CORD AND PLUG CONNECTED)

MODEL	REFRIGERANT	REFRIGERANT CHARGE (OZ)	ELECTRICAL	TOTAL SYSTEM AMPS	NEMA PLUG	AWEF	BTUH*	SHIP WT. (LB/KG)
CPB050PC-E-0	R290	5.25	115/60/1	6.9	5-15P	7.6	4100	206/93
CPB075PC-E-0		9.5**	115/60/1	11.4	5-20P	7.6	6700	228/103
CPB100PC-E-0		10.5***	115/60/1	15.3	5-20P	7.6	8800	271/123
CPF050PC-E-0		5.25	115/60/1	6.9	5-15P	2.84	1600	211/95
CPF075PC-E-0		9.5**	115/60/1	11.4	5-20P	2.91	2900	233/105
CPF100PC-E-0		10.5***	115/60/1	15.3	5-20P	2.96	3600	276/125
CPF150PC-E-4		10.5***	230/60/1	7.4	6-15P	3.01	4400	276/125
CPF175PC-E-4		10.5***	230/60/1	10.7	6-15P	3.12	6300	390/177

*BTUH calculated using 90°F ambient.
 **Two compressors using 4.75 oz each.
 ***Two compressors using 5.25 oz each.

Note:

- Consult factory for application specifics
- All Capsule Pak ECO systems require a single power supply.

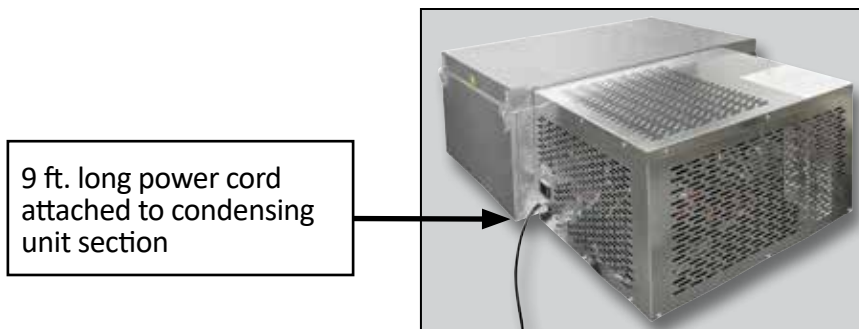

CAPSULE PAK™ REMOTE SYSTEMS



Evaporator section located on top of walk-in.

Condensing unit section remotely located.

Outdoor systems include ambient controls and weather-proof hoods with quick connects for simple field connections to pre-charged line lengths available in 5' increments up to 50' maximum. Wiring harnesses are also available and must be ordered by length (50' maximum).

Consult factory for application specifics, pricing, and ship date availabilities.

MODEL	REFRIGERANT	VOLTAGE	SYSTEM MCA	SYSTEM MAX. FUSE	AWEF	BTUH*	SHIP WT. (LB/KG)
COOLER MODELS							
CPB050JC-R-0-EV	R-449A	115/60/1	13.5	20	7.6	4394	270/122
CPB075JC-R-4-EV	R-449A	208-230/60/1	9.7	15	7.6	5729	285/129
CPB100JC-R-4-EV	R-449A	208-230/60/1	10.4	15	7.6	7300	285/129
FREEZER MODELS							
CPF060JC-R-4-EV	R-449A	208-230/60/1	8.9	15	2.9	2591	275/125
CPF075JC-R-4-EV	R-449A	208-230/60/1	9.7	15	2.93	3167	290/131
CPF100JC-R-4-EV	R-449A	208-230/60/1	11.2	15	2.94	3532	290/131
CPF150JC-R-4-EV	R-449A	208-230/60/1	17.1	20	3.03	4811	375/170
CPF200JC-R-4-EV	R-449A	208-230/60/1	17.6	30	3.13	6313	375/170

Note: Electrical specification intended to be single point connection (including electrical harness). All Capsule Pak Remote systems require one power supply and include an electrical harness to connect the condensing unit and evaporator sections.

*BTUH calculated using 90°F ambient.

Optional Electric Condensate Vaporizer

Capsule Pak Remote Systems are available with an electric condensate vaporizer. This UL and C-UL approved product requires no drain lines on indoor applications, which makes installation fast and easy and allows equipment to be operational in a shorter time frame.

NOTE: All specifications within this publication subject to change without notice.